

KORA

2

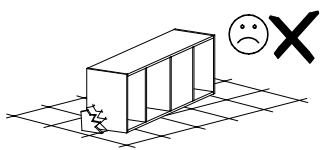

Narzędzia potrzebne do montażu

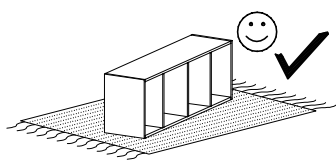
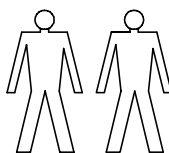
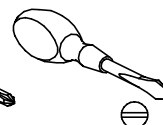
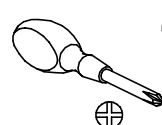
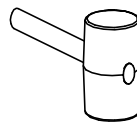
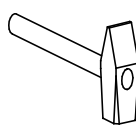

UWAGA !!

MONTOWANIE USZKODZONYCH
ELEMENTÓW POWODUJE UTRATĘ
GWARANCJI

nr	D[mm]	S[mm]	G[mm]	Ilość
1	465	565	65	1
2	465	565	65	1
3	1835	523	16	1
4	1835	523	16	1
5	373	523	16	1
6	1782	400	16	1
7	1860	396	2,5	1

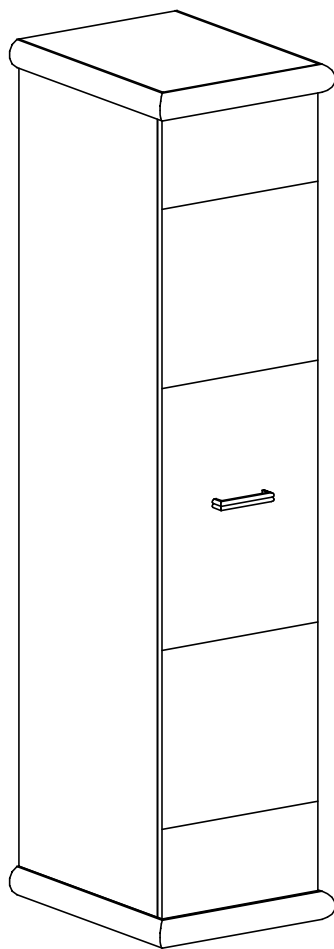

UWAGA !!

Mebel zawiera
elementy drewniane

W przypadku reklamacji proszę o podanie numeru pakowacza znajdującego się na kartonie



A1 - 4 St.
7 x 50 mm



A2 - 4 St.
6 x 50 mm



L - 12 St.

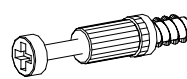

K - 12 St.



R - 1 St.
366mm

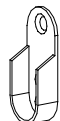

Y - 2 St.

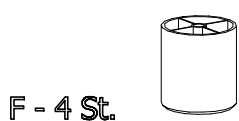

F - 4 St.

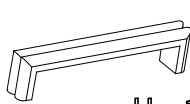

U - 1 St.

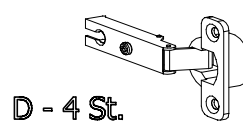

D - 4 St.

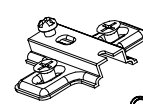

C - 4 St.



E - 50 St.



B - 12 St.

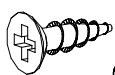

G - 12 St.
3,5 x 16 mm

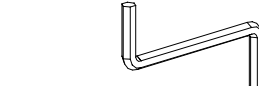

Z - 1 St.



N - 2 St.
4 x 30 mm

I

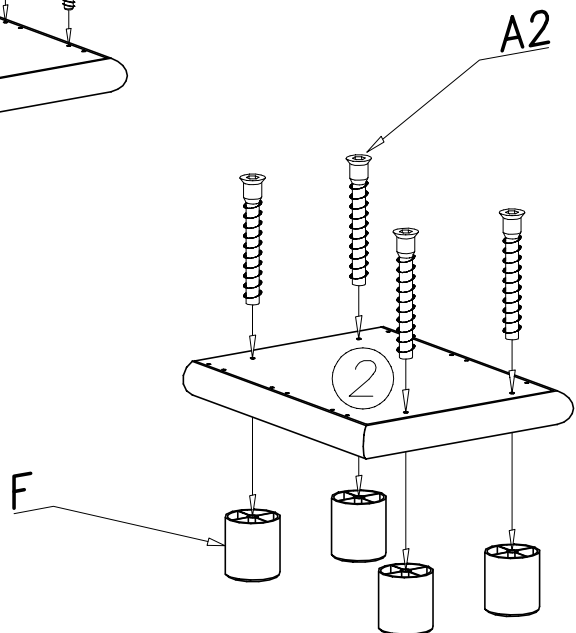
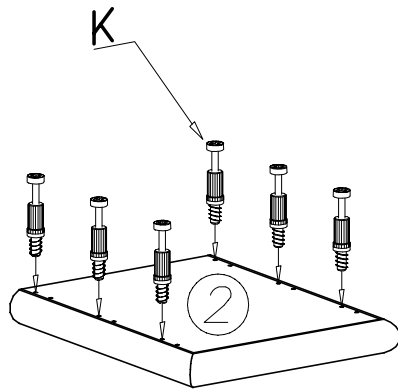
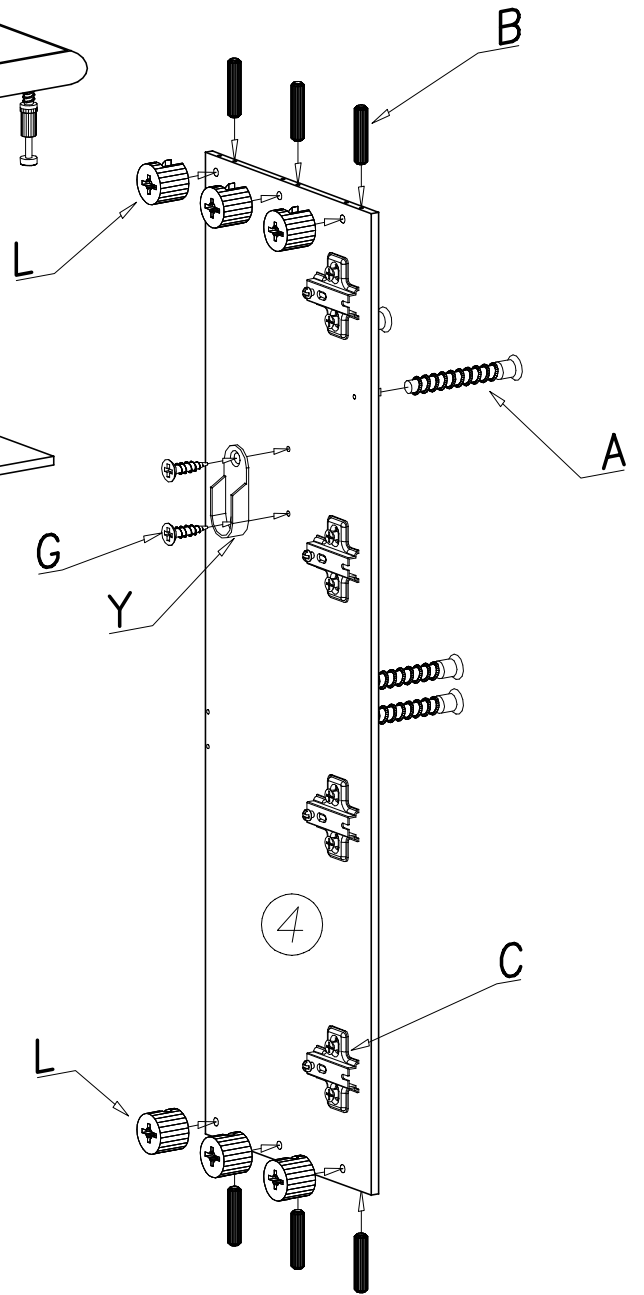
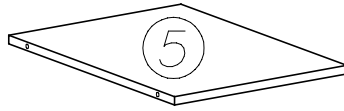
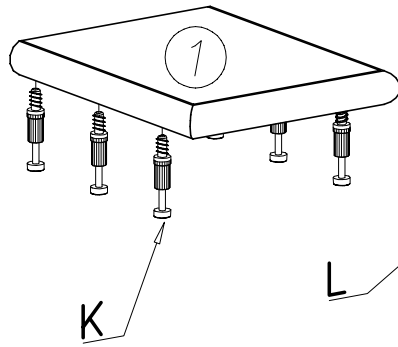
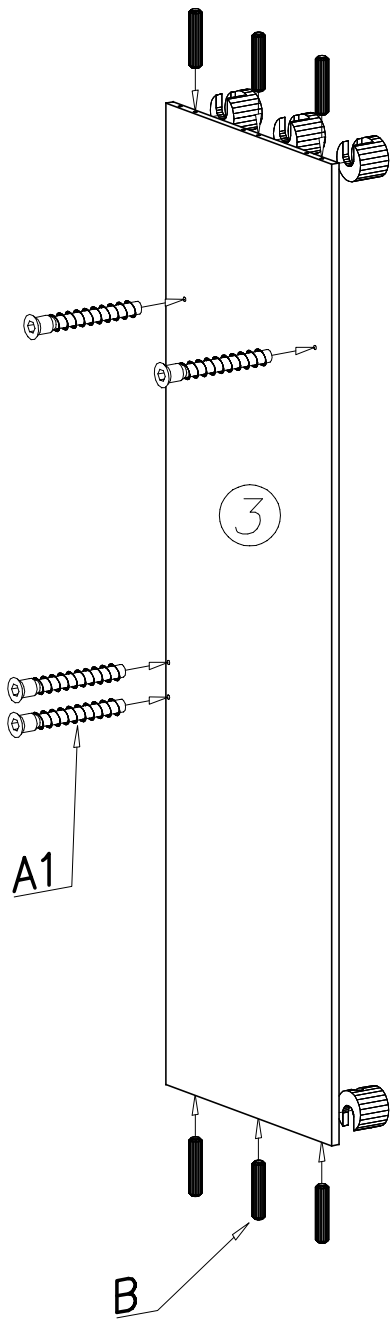

II

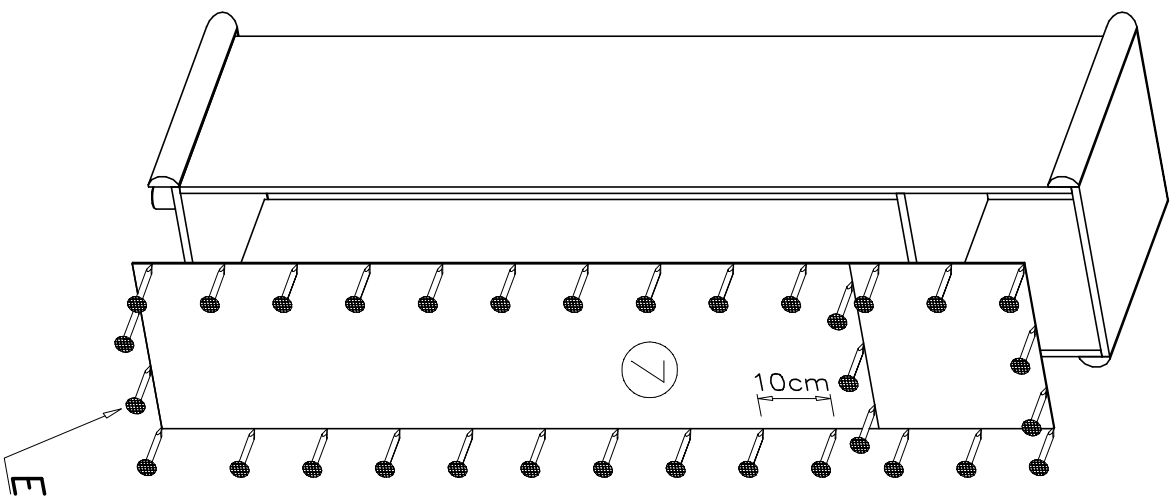

III

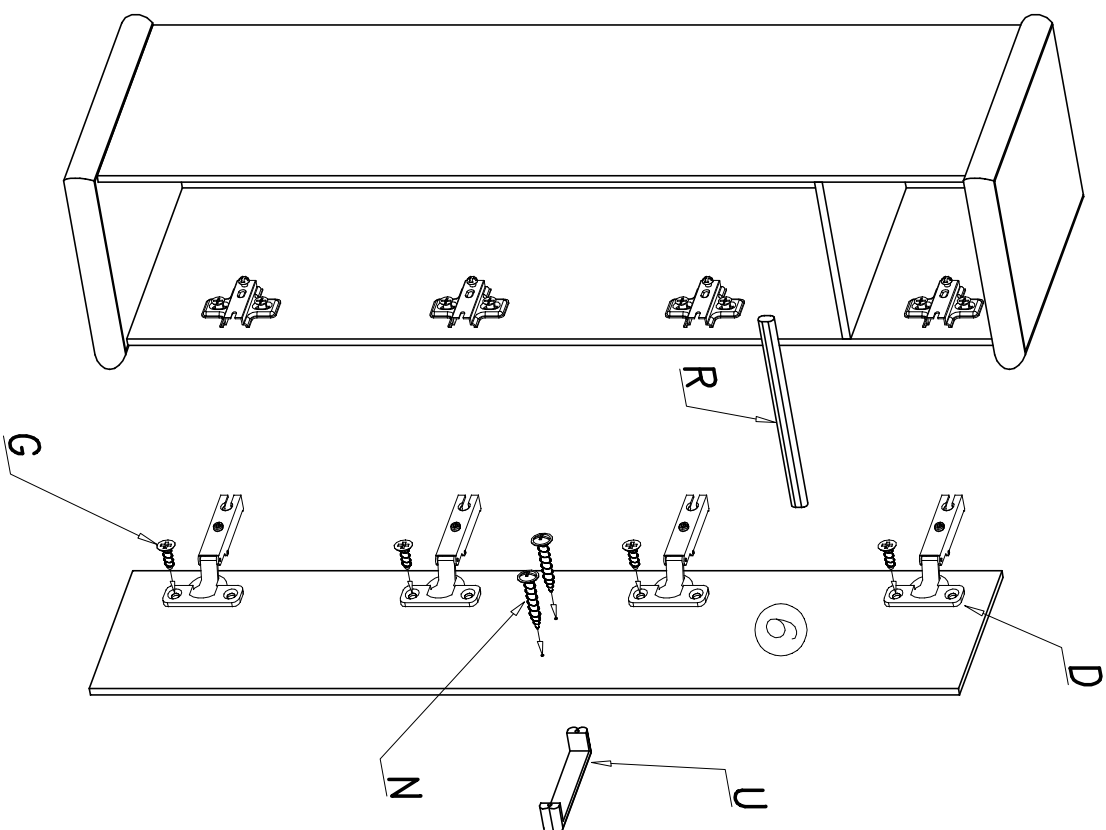

Meble zawierają elementy drewniane, których barwa i układ słojów są uzależnione od wielu czynników, dlatego mogą występować różnice w fakturze i barwie co nie stanowi wady produktu i nie wpływa na jego trwałość i funkcjonalność.

Listwy drewniane mogą ujawniać niewielkie zmiany w kształcie i wymiarach wywołane specyficznymi warunkami eksploatacji – wilgotność, różnice temperatur etc.